

**ECHOFLEX DEVICES**

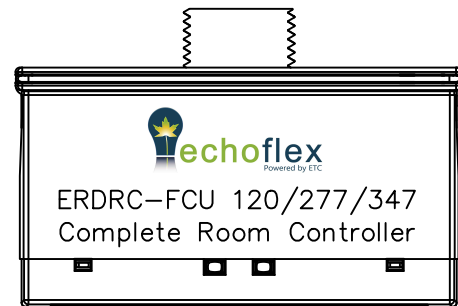

ERDRC-FCU 120/277/347  
Complete Room Controller

ERDRC-FCU

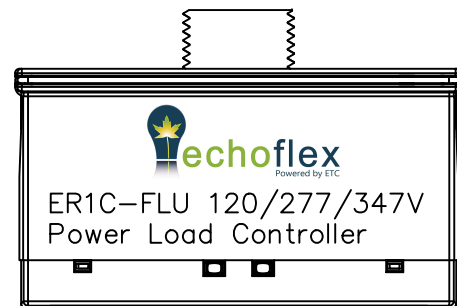

ER1C-FLU 120/277/347V  
Power Load Controller

ER1C-FLU

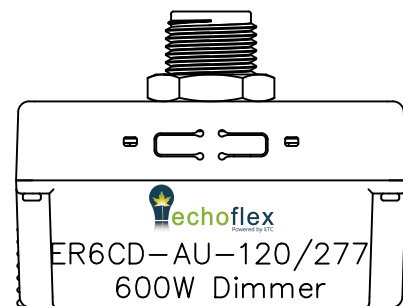

ER6CD-AU-120/277  
600W Dimmer

ER6CD-AU

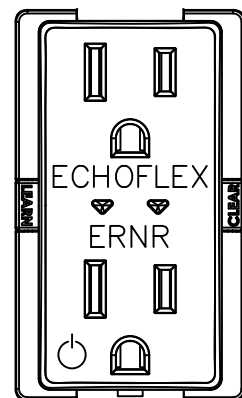

ERNR

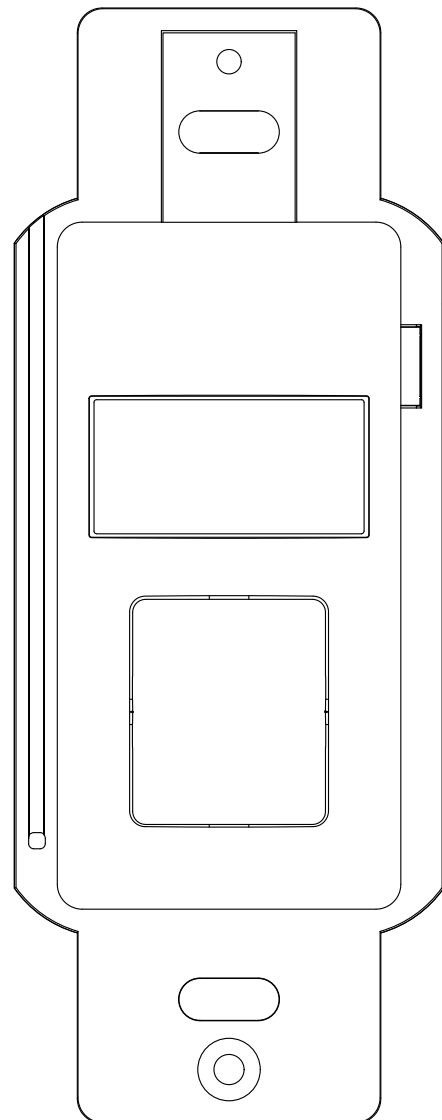

120V/277V Line

GROUND

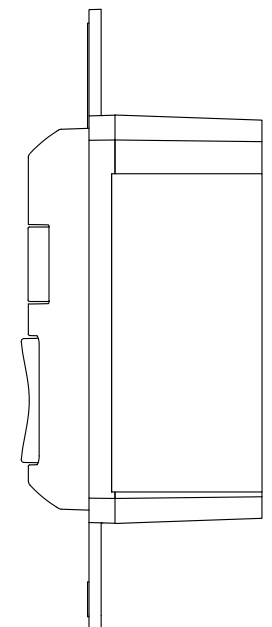
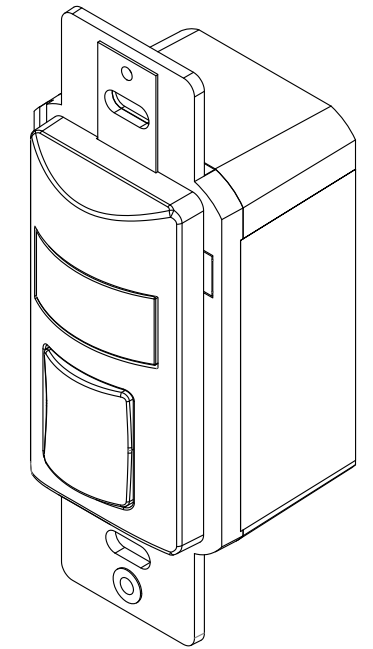

**Echoflex OWS-DT-120/277**

- Communicates on 902 MHz frequency
- Dual Technology, Passive Infrared & Acoustic Interface
- On/Off Switching & Up/Down Dimming
- Radio Range minimum 80' laterally Obstructed and 300' unobstructed
- Mounts in a Standard Single Gang Ring or Box

<b>DEVICE:</b> Dual Technology Occupancy/Vacancy Wall Switch Sensor		<b>Echoflex Solutions, Inc.</b> 38924 Queens Way Unit #1 Squamish, British Columbia Canada V8B 0K8 Phone: 1 (778) 733-0111 Toll Free: 1 (888) 324-6359 Fax: 1 (604) 815-0078 www.echoflexsolutions.com
<b>VOLTAGE RATING:</b> 120VAC OR 277VAC		
<b>MAXIMUM AMOUNT OF WIRELESS DEVICES CONNECTED:</b> Infinite		
<b>ELECTRICAL CONNECTION:</b> NO NEUTRAL DESIGN, WIRE LEADS 250mm (10.0")		
<b>Part #:</b> OWS-DT-120/277	<b>DOCUMENT NO:</b> 8DC-9464	
UNLESS OTHERWISE SPECIFIED - ALL DIMENSIONS ARE IN MILLIMETERS.		