

ECHOFLEX DEVICES

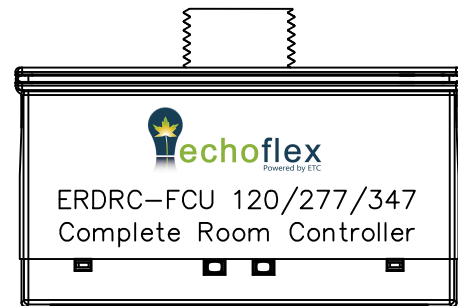

ERDRC-FCU 120/277/347
Complete Room Controller

ERDRC-FCU

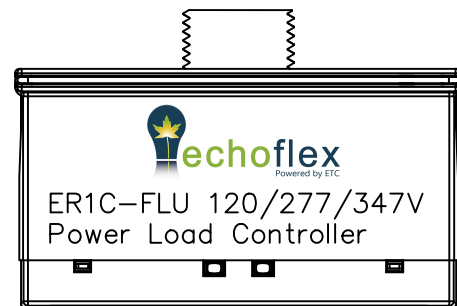

ER1C-FLU 120/277/347V
Power Load Controller

ER1C-FLU

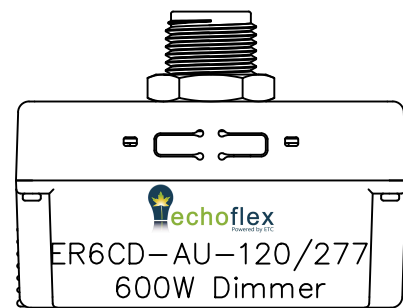

ER6CD-AU-120/277
600W Dimmer

ER6CD-AU

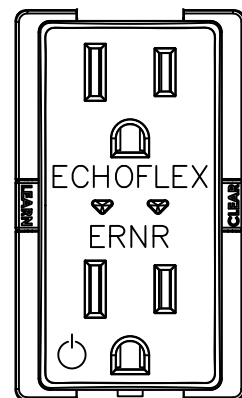

ERNR

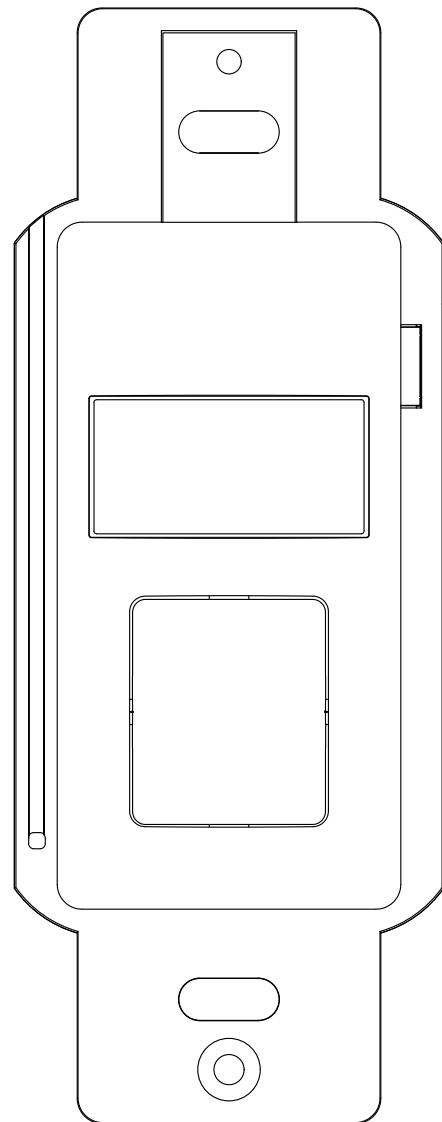

120V/277V Line

GROUND

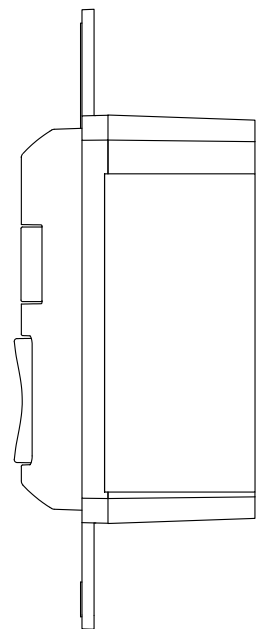
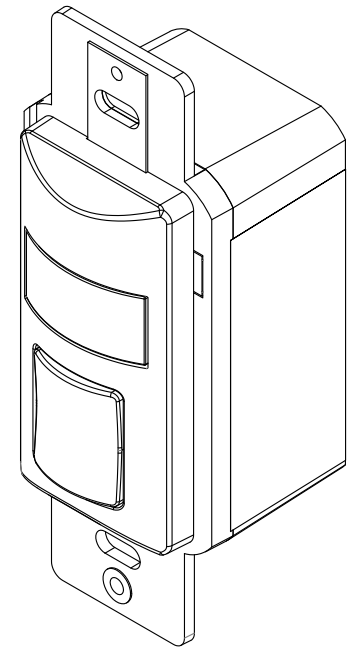

Echoflex OWS-IR-120/277

- Communicates on 902 MHz frequency
- Passive Infrared Technology
- On/Off Switching & Up/Down Dimming
- Radio Range minimum 80' laterally Obstructed and 300' unobstructed
- Mounts in a Standard Single Gang Ring or Box

DEVICE: Passive Infrared Occupancy/Vacancy Wall Switch Sensor		Echoflex Solutions, Inc. 38924 Queens Way Unit #1 Squamish, British Columbia Canada V8B 0K8 Phone: 1 (778) 733-0111 Toll Free: 1 (888) 324-6359 Fax: 1 (604) 815-0078 www.echoflexsolutions.com
VOLTAGE RATING: 120VAC OR 277VAC		
MAXIMUM AMOUNT OF WIRELESS DEVICES CONNECTED: Infinite		
ELECTRICAL CONNECTION: NO NEUTRAL DESIGN, WIRE LEADS 250mm (10.0")		
Part #: OWS-IR-120/277	DOCUMENT NO: 8DC-9476	
UNLESS OTHERWISE SPECIFIED - ALL DIMENSIONS ARE IN MILLIMETERS.		